

Sadu 132.100.002

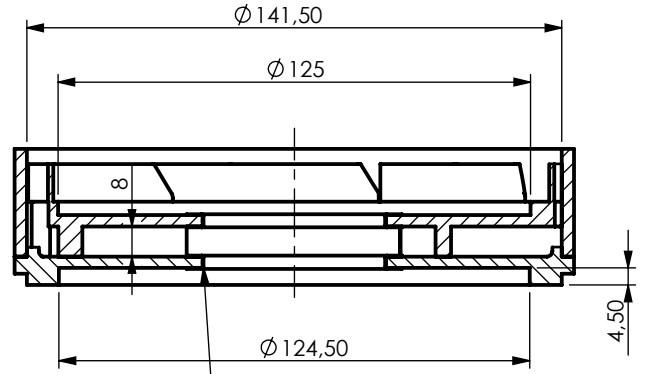

İki adet Aşınma halkası
(Krom)

Kanat sayısı 7 adet

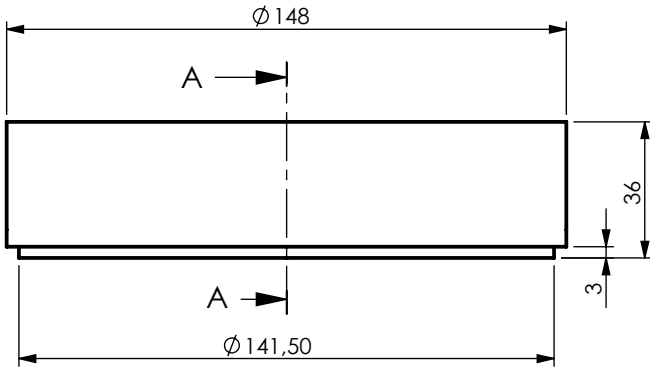
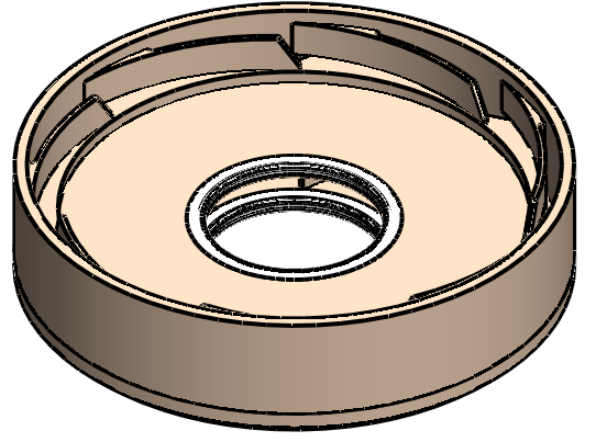